

专利产品

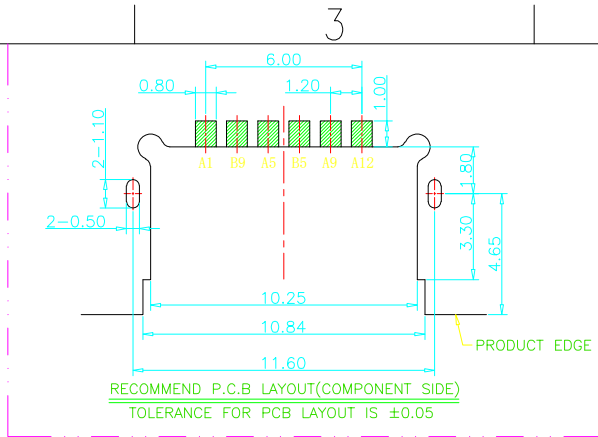
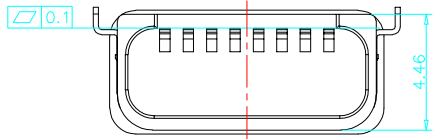

REV.	ECN	DESCRIPTION	MDF'D	DATE
A0		新订图面	Lee	2022.06.28

- NOTES:
SPECIFICATION:
1.CURRENT RATING: 3.0 A
2.VOLTAGE RATING: 3.0 V
3.VBUS & GND PINS AND OTHER PINS: 40mΩ/PIN MAX
SHIELD: 50mΩ/MAX
LLCR MAX. CHANGE OF ALL PINS: 10Qm
4.INSULATION RESISTANCE: 100MΩ MIN
5.DIELECTRIC WITHSTAND VOLTAGE, AC 100V FOR 1MINUTE
6.INSERTION FORCE: 0.5-2.0kgf
7.UNMATING FORCE: 0.8-2.0kgf
8.DURABILITY: 10000 CYCLES
9.OPERATING TEMPERATURE: -35°C~+85°C
10.THE PEAK TEMPERATURE ON THE BOARD SHALL BE MAINTAINED FOR 10 SECONDS AT 210-230°C
11.WATERPROOF: IP-X7.

A

A

B

B

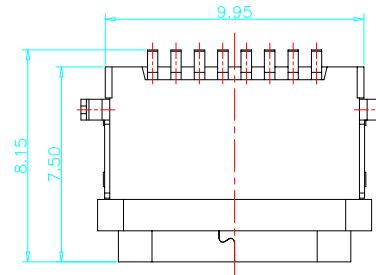
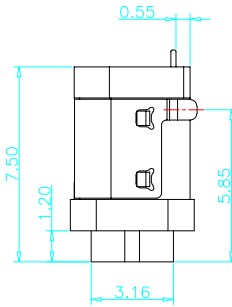
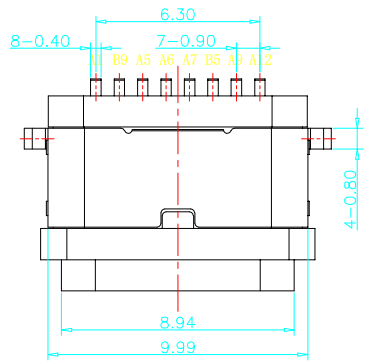

C

C

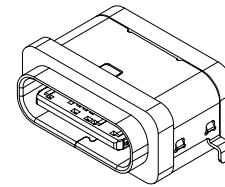
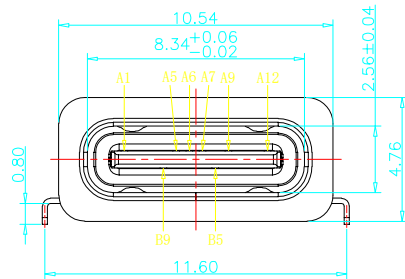

USB TYPE C PIN ASSIGNMENTS

PIN NUMBER	SIGNAL NAME	PIN NUMBER	SIGNAL NAME
A1	GND	B9	VBUS
A5	CC1		
A6	D+		
A7	D-		
A9	VBUS	B5	CC2
A12	GND		

TABLE:

NO	PART	QTY	Material
1	SHELL	1	STAINLESS STEEL, NI PLATED
2	CONTACT	8	COPPER STEEL, TIN/AU/NI PLATED
3	MID PLATE	1	STAINLESS STEEL, NO PLATING
4	1MD HOUSING	1	HIGH TEMPERATURE RESISTANT PLASTIC BLACK UL94 V-0
5	2MD HOUSING	1	HIGH TEMPERATURE RESISTANT PLASTIC BLACK UL94 V-0
6	SHIELDING PLATE	1	STAINLESS STEEL, NI PLATED

D

D



东莞市溪榜电子有限公司

DONG GUAN XI BANG ELECTRONICS CO., LTD.

品名 (ITEM NO)	TYPE C 8P 沉板防水母座B款 (带钢片) (护脚外壳2脚插板, 端子SMT)
料号 (PART NO)	
图号 (DWG NO)	

页码 (SHEET)	1/1	单位 (UNIT): MM
版本 (REV)	A0	比例 (SCALE) 1:1
日期 (DATE)	2022.06.28	☉
设计 (DESIGN)	Lee	未注公差 TOLERANCE UNSPECIFIED
审核 (CHECKED)	LSW	X.X ±0.20
核准 (APPROVED)	CJL	X.XX ±0.15
		X.XXX ±0.10
		X° ±5°
		X. X' ±2°

These drawings and specifications are the property of Dongguan Xibang Electronics Co., Ltd. and should not be copied. Without the prior written consent of Dongguan Xibang Electronics Co., Ltd., it shall not be copied or used in any way.

1

2

3

4

5